

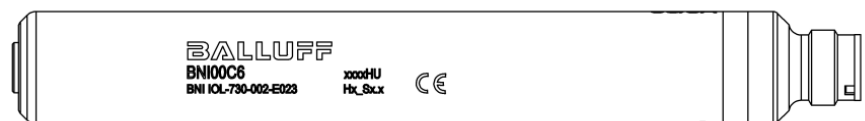

**BNI IOL-717-002-E023**  
**BNI IOL-725-002-E023**  
**BNI IOL-730-002-E023**  
**BNI IOL-740-002-E023**  
**User's Guide**



<b>1</b>	<b>Notes for the user</b>	<b>3</b>
1.1.	<b>Structure of the guide</b>	<b>3</b>
1.2.	<b>Typographical Conventions</b>	<b>3</b>
	Enumerations	3
	Actions	3
	Syntax	3
	Cross references	3
1.3.	<b>Symbols</b>	<b>3</b>
1.4.	<b>Abbreviations</b>	<b>3</b>
1.5.	<b>Differing views</b>	<b>3</b>
<b>2</b>	<b>Safety</b>	<b>4</b>
2.1.	<b>Intended use</b>	<b>4</b>
2.2.	<b>Installation and startup</b>	<b>4</b>
2.3.	<b>General safety notes</b>	<b>4</b>
2.4.	<b>Resistance to Aggressive Substances</b>	<b>4</b>
	Hazardous voltage	4
<b>3</b>	<b>Getting Started</b>	<b>5</b>
3.1.	<b>Connection overview</b>	<b>5</b>
3.2.	<b>Electrical connection</b>	<b>6</b>
	IO-Link Interface	6
	Connecting the Analog converter	6
	Function ground	6
	Module versions	6
3.3.	<b>Functionality</b>	<b>7</b>
3.4.	<b>Sensor Interface</b>	<b>8</b>
3.5.	<b>Input signal range</b>	<b>11</b>
3.6.	<b>Output signal range</b>	<b>11</b>
3.7.	<b>Data formats</b>	<b>11</b>
3.8.	<b>Signed data format</b>	<b>12</b>
3.9.	<b>Unsigned data format</b>	<b>13</b>
3.10.	<b>Dimensioned data format</b>	<b>15</b>
<b>4</b>	<b>IO-Link Interface</b>	<b>17</b>
4.1.	<b>IO-Link Data</b>	<b>17</b>
4.2.	<b>Process data / Input data</b>	<b>18</b>
	BNI IOL-717-002-E023 / BNI IOL-730-002-E023 / BNI IOL-740-002-E023	18
4.3.	<b>Process data / Output data</b>	<b>18</b>
	BNI IOL-725-002-E023 / BNI IOL-730-002-E023	18
4.4.	<b>Parameter data / Request data</b>	<b>19</b>
	Device Temperature	21
	52hex	21
	Setting the serial number 54hex	21
	Operating hours	21
	57hex	21
	Boot counter	21
	58hex	21
	Process data alignment 59hex	22
	Analog mode F0hex	22
	Resolution F1hex	24
	Pin assignment F2hex	24
	Pt100/Pt1000 mode F3hex	25
	Process data format F5hex	25
	Switch point 1, F6hex Switch point 2, F7hex	25
	Switch point enable F8hex	25
	Thermocouple grounding F9hex	26
	Fault state outputs	26
	FAhex	26

4.5. Error	27
4.6. Events	27
<b>5 Technical Data</b>	<b>28</b>
5.1. Dimensions	28
5.2. Mechanical Data	28
5.3. Electrical Data	28
5.4. Operating conditions	28
5.5. LED indicators	29
Status LEDs	29
<b>6 Appendix</b>	<b>30</b>
6.1. Type designation code	30
6.2. Order information	30

## 1 Notes for the user

- 1.1. Structure of the guide** The guide is organized so that the sections build on one another:  
Section 2: Basic safety information.  
Section 3: The main steps for installing the device.  
.....
- 1.2. Typographical Conventions** The following typographical conventions are used in this guide.
- Enumerations** Enumerations are shown in list form with a dash.
- Entry 1,
  - Entry 2.
- Actions** Action instructions are indicated by a preceding triangle. The result of an action is indicated by an arrow.
- Action instruction 1.
    - ↳ Action result.
  - Action instruction 2.
- Syntax** **Numbers:**  
Decimal numbers are shown without additional indicators (e.g. 123),  
Hexadecimal numbers are shown with the additional indicator hex (e.g. 00hex).
- Cross references** Cross references indicate where additional information on the topic can be found.
- 
- 1.3. Symbols**
-  **Attention!**  
This symbol indicates a security notice which must be observed.
- 
-  **Note**  
This symbol indicates general notes.
- 
- 1.4. Abbreviations**
- |      |                               |
|------|-------------------------------|
| BNI  | Balluff Network Interface     |
| DPP  | Direct Parameter Page         |
| EMC  | Electromagnetic Compatibility |
| FE   | Function Earth                |
| IOL  | IO-Link                       |
| ISDU | Index Service Data Unit       |
| MSB  | Most significant bit          |
- 1.5. Differing views** Product views and images in this manual may differ from the product described. They are intended to serve only as illustrations.

2 Safety

2.1. Intended use

This guide describes the Balluff Network Interface family BNI IOL-7xx-002-E023 for the application as peripheral analog input module to establish connection of analog sensors, RTDs and thermocouple sensors and/or analog output modules. Hereby it is about an IO-Link device which communicates by means of IO-Link protocol with the superordinate IO-Link master assembly.

2.2. Installation and startup



**Attention!**

Installation and startup are to be performed only by trained specialists. Qualified personnel are persons who are familiar with the installation and operation of the product, and who fulfills the qualifications required for this activity. Any damage resulting from unauthorized manipulation or improper use voids the manufacturer's guarantee and warranty. The Operator is responsible for ensuring that applicable of safety and accident prevention regulations are complied with.

2.3. General safety notes

**Commissioning and inspection**

Before commissioning, carefully read the operating manual. The system must not be used in applications in which the safety of persons is dependent on the function of the device.

**Authorized Personnel**

Installation and commissioning may only be performed by trained specialist personnel.

**Intended use**

Warranty and liability claims against the manufacturer are rendered void by:

- Unauthorized tampering
- Improper use
- Use, installation or handling contrary to the instructions provided in this operating manual

**Obligations of the Operating Company**

The device is a piece of equipment from EMC Class A. Such equipment may generate RF noise. The operator must take appropriate precautionary measures. The device may only be used with an approved power supply. Only approved cables may be used.

**Malfunctions**

In the event of defects and device malfunctions that cannot be rectified, the device must be taken out of operation and protected against unauthorized use.

Intended use is ensured only when the housing is fully installed.

2.4. Resistance to Aggressive Substances



**Attention!**

The BNI modules always have good chemical and oil resistance. When used in aggressive media (such as chemicals, oils, lubricants and coolants, each in a high concentration (i.e. too little water content)), the material must first be checked for resistance in the particular application. No defect claims may be asserted in the event of a failure or damage to the BNI modules caused by such aggressive media.

Hazardous voltage



**Attention!**

Disconnect all power before servicing equipment.



**Note**

In the interest of product improvement, the Balluff GmbH reserves the right to change the specifications of the product and the contents of this manual at any time without notice.

### 3 Getting Started

#### 3.1. Connection overview

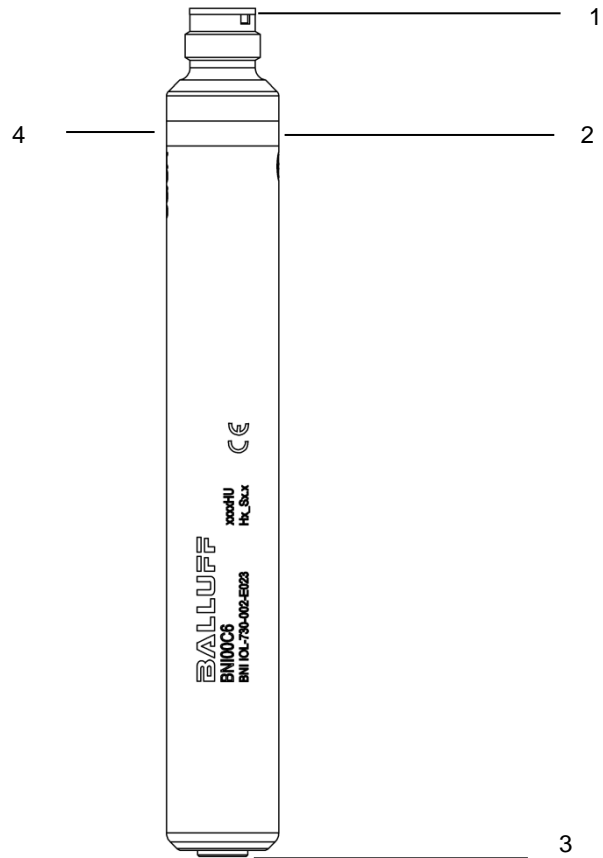

Fig. 3-1: BNI IOL-7xx-002-E023

- |   |                                   |   |                          |
|---|-----------------------------------|---|--------------------------|
| 1 | IO-Link interface                 | 3 | Analog connector         |
| 2 | Status LED: IO-Link communication | 4 | Status LED: Power supply |

3 Getting Started

3.2. Electrical connection

The BNI IOL-7xx-002-E023 modules require no separate supply voltage connection. Power is provided through the IO-Link interface by the host IO-Link Master.

IO-Link Interface

IO-Link (M12, A-coded, male)

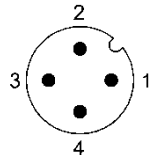

Pin	Function
1	Power supply controller US, +24V
2	Power supply outputs UA, +24V*
3	GND, reference potential
4	C/Q, IO-Link data transmission channel

\*only in case of variants, with analog output

Connecting the Analog converter

- Connection protection ground to the housing of the Analog converter.
- Connect the incoming IO-Link line to the Analog converter.



Note

A standard 3 or 4 wire sensor cable is used for connection to the host IO-Link master.

Function ground



Note

The housing of the BNI IOL-7xx-002-E023 must be connected to the protection ground and it must be low-impedance and kept as short as possible.

Module versions

Version	Analog function
BNI IOL-717-002-E023	Input (voltage, current, Pt100 and Pt1000)
BNI IOL-725-002-E023	Output (voltage, current)
BNI IOL-730-002-E023	Input, Output, Temperature (voltage, current, thermocouple TypJ, TypK, Pt100, Pt1000)
BNI IOL-740-002-E023	Temperature (thermocouple TypJ, TypK, Pt100, Pt1000)

### 3.3. Functionality

The BNI IOL-7xx-002-E023 module has an analog port. The ports can be configured to accept voltage signal, current signal, Pt sensor or thermocouples, depending on the version. Some version has an analog voltage/current output.

Analog port type	Nominal range
Voltage	0 V - 10 V
Voltage	5 V - 10 V
Voltage	-10 V - +10 V
Voltage	0 V - 5 V
Voltage	-5 V - +5 V
Current	4 - 20 mA
Current	0 - 20 mA
Pt100	-200 °C - +850 °C
Pt1000	-200 °C - +850 °C
Typ J	-100 °C - +1200 °C
Typ K	-180 °C - +1370 °C

In case of voltage/current type sensor the input pin of the analog port can be configured. The analog input signal can be connected either to pin2 or pin4. In this case the input/output is a voltage or current input/output, the BNI IOL-7xx-002-E023 has a +24V power supply output, in order to power the connected sensor or actuator.

In case of RTD sensor (Pt100, Pt1000), the sensor can be connected with 2 wire, 3 wire or 4 wire method.



3 Getting Started

3.4. Sensor Interface Analog port (M12, A-coded, female)

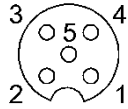

Pin	Voltage / Current input
1	+24 V, 200 mA (sensor supply)
2	Voltage / current input
3	GND (sensor supply, measurement)
4	Voltage / current input
5	-

Pin	Voltage / Current output
1	+24 V, 1.4 A (actor supply)
2	Voltage / current output*
3	GND (sensor supply)
4	Voltage / current output*
5	-

Pin	Pt100, Pt1000 2 wire
1	Current Source 1 - / Analog In -
2	Current Source 1 - / Analog In -
3	-
4	Current Source 1 + / Analog In +
5	-

Pin	Pt100, Pt1000 3 wire
1	Current Source -
2	Current Source 2 + / Analog In -
3	-
4	Current Source 1 + / Analog In +
5	-

Pin	Pt100, Pt1000 4 wire
1	Current Source -
2	Analog In -
3	Analog In +
4	Current Source +
5	-

Pin	Thermocouple Typ J, Typ K
1	-
2	Thermocouple +
3	Thermocouple -
4	-
5	-

\* In case of voltage/current output the output signal appears between pin2 and pin4. The polarity of the output signal depends on the pin assignment configuration. For further description please see IO-Link interface description.

---

**Note**

Pin 1 is the supply voltage output for the connected sensor/actuator. Depending on the direction, the pin1 supply voltage can be loaded with 200 mA (input configuration) or 1.4A (output configuration). In case of input configuration the Pin1 of the IO-Link port is the source of the +24V supply on analog port. In case of output configuration, the Pin2 of the IO-Link port is the source of the +24V supply on analog port.

---

**Attention!**

The +24V on Pin1 is short circuit protected in case of BNI IOL-717-002-E023 and BNI IOL-730-002-E023.

In case of BNI IOL-725-002-E023 the Pin1 of the analog port is directly connected to the Pin2 of the IO-Link port. **There is no short circuit protection in this case.** In case the module is connected to an IO-Link master, the master should have short circuit protection on pin2.

**Commissioning Note:**

**The device must be configured for the required function, before connecting to the sensor interface.**

---

3 Getting Started

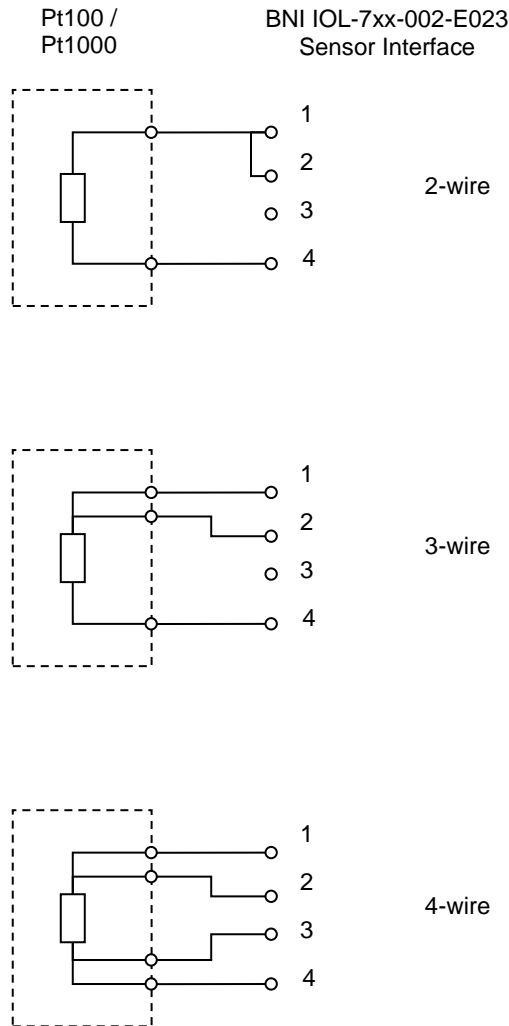

---

**Note**  
**i** The analog signals shall be connected with a shielded cable to the BNI IOL-7xx-002-E023. The BNI IOL-7xx-002-E023 should be placed as close to the source of the analog signal as possible. The length of the cable with analog signals should not exceed the 3 meter.

---

**Note**  
**i** In order to achieve better accuracy in case of thermocouple measurement, the thermocouple should be connected to the device with a special M12 connector for thermocouples (Typ J or Typ K, depending on the thermocouple.).

---

**3.5. Input signal range** The BNI IOL-7xx-002-E023 supports many standard input signal ranges. In some cases an analog sensor has higher linear output range than the nominal output range. For example a sensor with a 0 – 10 V output can source voltages between -0.5V and 10.5V, and indicates error with a signal <-0.5V or >10.5V. Therefore the BNI IOL-7xx-002-E023 has the following input ranges for the different analog modes.

Analog mode	V <sub>min</sub> [V]	V <sub>max</sub> [V]
0 V – 10 V	-0.5	10.5
5 V – 10 V	4.5	10.5
-10 V – 10 V	-10.5	10.5
0 V – 5 V	-0.5	5.5
-5 V – 5 V	-5.5	5.5

Analog mode	I <sub>min</sub> [mA]	I <sub>max</sub> [mA]
4 mA – 20 mA	3.8	20.5
0 mA – 20 mA	0	20.5

Analog mode	T <sub>min</sub> [°C]	T <sub>max</sub> [°C]
Pt100	-200	850
Pt1000	-200	850
Typ J (ungrounded)	-100	1200
Typ J (grounded)	-100	400
Typ K (ungrounded)	-180	1370
Typ K (grounded)	-100	400

**3.6. Output signal range** The variants with analog outputs (BNI IOL-725-002-E023, BNI IOL-730-002-E023) supports the same output voltage ranges as the inputs, but the output voltage/current range is the same as the nominal range.

Analog mode	V <sub>min</sub> [V]	V <sub>max</sub> [V]
0 V – 10 V	0	10
5 V – 10 V	5	10
-10 V – 10 V	-10	10
0 V – 5 V	0	5
-5 V – 5 V	-5	0

Analog mode	I <sub>min</sub> [mA]	I <sub>max</sub> [mA]
4 mA – 20 mA	4	20
0 mA – 20 mA	0	20

**3.7. Data formats** The signal on the analog port of the BNI IOL-7xx-002-E023 (input or output signal) will be represented as a digitalized value and sent as a process data over IO-Link. The digitalized value can be represented in different formats (signed, unsigned or dimensioned), in different resolution (16, 14, 12 or 10 bit), with different alignment (left or right aligned).

### 3 Getting Started

#### 3.8. Signed data format

In case of signed data format, the digital value is represented in a two's complement format (15 bit + sign, 13 bit + sign, 11 bit + sign, 9 bit + sign depending on the resolution.).

For different configurations, the analog signal (voltage, current, temperature) can be calculated with the following formulas.

##### Voltage signal (0V-10V, -10V - +10V, 0V - 5V, -5V - +5V):

In case of positive numbers (MSB = 0):

$$\text{Voltage [V]} = \text{PortValue} * \frac{V_{\max}}{2^{(N-1)} - 1}$$

In case of negative numbers (MSB = 1):

$$\text{Voltage [V]} = (\text{PortValue} - 2^N) * \frac{V_{\max}}{2^{(N-1)} - 1}$$

##### Voltage signal (5V – 10V):

$$\text{Input voltage [V]} = \text{PortValue} * \frac{V_{\max} - V_{\min}}{2^{(N-1)} - 1} + V_{\min}$$

##### Current signal (0-20mA, 4-20mA):

$$\text{Current [mA]} = \text{PortValue} * \frac{I_{\max} - I_{\min}}{2^{(N-1)} - 1} + I_{\min}$$

##### Pt100, Pt1000, Typ J, Typ K:

In case of positive numbers (MSB = 0):

$$\text{Temperature [°C]} = \text{PortValue} * \frac{T_{\max}}{2^{(N-1)} - 1}$$

In case of negative numbers (MSB = 1):

$$\text{Temperature [°C]} = (\text{PortValue} - 2^N) * \frac{T_{\max}}{2^{(N-1)} - 1}$$

Where:

PortValue is the digitalized value of the input signal.

N is the resolution in bits.

$V_{\max}$ ,  $I_{\max}$ ,  $T_{\max}$  are the higher limits of the selected input range.

$V_{\min}$ ,  $I_{\min}$ ,  $T_{\min}$  are the lower limits of the selected input range.

##### Example 1:

The analog mode is set to 0-10V input.

The resolution is 14 bit.

The process data is right aligned.

The digitalized value read over IO-Link is  $1234_{\text{hex}} = 4660$ .

The most significant bit of  $1234_{\text{hex}}$  is 0, so it is a positive number. In this case the voltage can be calculated with the following formula:

$$\text{Input voltage [V]} = \text{PortValue} * \frac{V_{\max}}{2^{(N-1)} - 1} = 4660 * \frac{10.5V}{2^{(14-1)} - 1} = 5,974V$$

**Example 2:**

The analog mode is set to -10V - +10V input.  
 The resolution is 12 bit.  
 The process data is left aligned.  
 The digitalized value read over IO-Link is ABC0<sub>hex</sub>

The 12 bit value is left aligned, so the 16 bit value read over IO-Link must be shifted right by four (the 12 bit value is ABC<sub>hex</sub>). The most significant bit of the 12 bit value is 1, so it represents a negative number, therefore the voltage can be calculated with the following formula:

$$\text{Input voltage [V]} = (\text{PortValue} - 2^N) * \frac{V_{\max}}{2^{(N-1)} - 1} = (\text{ABC}_{\text{hex}} - 2^{12}) * \frac{10.5V}{2^{(12-1)} - 1} = -6.915 V$$

**Example 3:**

The analog mode is set to 4-20 mA output  
 The resolution is 16 bit.  
 The digital value written over IO-Link is 4000<sub>hex</sub>= 16384  
 The most significant bit of 3FFF<sub>hex</sub> is 0, so it is a positive number. In this case the voltage can be calculated with the following formula:

$$\text{Output current [mA]} = \text{PortValue} * \frac{I_{\max} - I_{\min}}{2^{(N-1)} - 1} + I_{\min} = 16384 * \frac{20\text{mA} - 4\text{mA}}{2^{(16-1)} - 1} + 4\text{mA} = 12\text{mA}$$

**3.9. Unsigned data format**

In case of unsigned data format, the analog signal will be represented as a number between 0000<sub>hex</sub> and the full scale value according to the resolution (FFFF<sub>hex</sub> in case of 16 bit resolution). The analog signal of the BNI IOL-7xx-002-E032 can be calculated from the digital value with the following formulas:

**Voltage signal (0V-10V, 5V – 10V, -10V - +10V, 0V - 5V, -5V - +5V):**

$$\text{Voltage [V]} = \text{PortValue} * \frac{V_{\max} - V_{\min}}{2^N - 1} + V_{\min}$$

**Current signal (0-20mA, 4-20mA):**

$$\text{Current [mA]} = \text{PortValue} * \frac{I_{\max} - I_{\min}}{2^N - 1} + I_{\min}$$

**Pt100, Pt1000, Typ J, Typ K:**

$$\text{Temperature [°C]} = \text{PortValue} * \frac{T_{\max} - T_{\min}}{2^N - 1} + T_{\min}$$

Where:

PortValue is the digitalized value of the input signal.

N is the resolution in bits.

V<sub>max</sub>, I<sub>max</sub>, T<sub>max</sub> are the higher limits of the selected input range.

V<sub>min</sub>, I<sub>min</sub>, T<sub>min</sub> are the lower limits of the selected input range.

**Example 1:**

The analog mode is set to 0-10V input.  
 The resolution is 14 bit.  
 The process data is right aligned.  
 The digitalized value read over IO-Link is 2345<sub>hex</sub> = 9029.

In case of 0-10V, the analog input voltage range is between -0.5V and 10.5V.  
 Therefore V<sub>min</sub> = -0.5V, V<sub>max</sub>=10.5V.

$$\text{Input voltage [V]} = \text{PortValue} * \frac{V_{\max} - V_{\min}}{2^N - 1} + V_{\min} = 9029 * \frac{10.5V - (-0.5V)}{2^{14} - 1} + (-0.5V) = 5.562V$$

### 3 Getting Started

#### Example 2:

The analog mode is set to 4-20 mA input.

The resolution is 12 bit.

The process data is left aligned.

The digitalized value read over IO-Link is ABC0<sub>hex</sub>

In case of 4-20 mA, the analog input current range is between 3.8 mA and 20.5 mA. The digitalized value is read over IO-Link as a 16 bit value, but the resolution is 12 bit and it is left aligned, so the 12 bit digitalized data is ABC<sub>hex</sub> = 2748.

$$\text{Input current [mA]} = \text{PortValue} * \frac{I_{\max} - I_{\min}}{2^N - 1} + I_{\min} = 2748 * \frac{20.5\text{mA} - 3.8\text{mA}}{2^{12} - 1} + 3.8\text{mA} = 15.007\text{mA}$$

#### Example 3:

The analog mode is set to TypJ Thermocouple.

The resolution is 16 bit

The digitalized value read over IO-Link is 4567<sub>hex</sub> = 17767

$$\begin{aligned} \text{Temperature [}^\circ\text{C]} &= \text{PortValue} * \frac{T_{\max} - T_{\min}}{2^N - 1} + T_{\min} = 17767 * \frac{1200^\circ\text{C} - (-100^\circ\text{C})}{2^{16} - 1} + (-100^\circ\text{C}) \\ &= 252.44^\circ\text{C} \end{aligned}$$

#### Example 4:

The analog mode is set to Voltage output 0 – 5 V.

The resolution is 16 bit.

The digital value written over IO-Link is 8000<sub>hex</sub> = 32768.

$$\text{Output voltage [V]} = \text{PortValue} * \frac{V_{\max} - V_{\min}}{2^N - 1} + V_{\min} = 32768 * \frac{5 - 0}{2^{16} - 1} + 0 = 2.5\text{V}$$

**3.10. Dimensioned data format**

In case of dimensioned format, the voltage, current or temperature will be represented in mV,  $\mu\text{A}$  or  $^{\circ}\text{C}$  (in  $0.1^{\circ}\text{C}$  step). In this case the resolution and process data alignment settings do not influence the data. It must be always handled as a right aligned data, and as a 16 bit value.

**Voltage signal (0V-10V, 5V – 10V, -10V - +10V, 0V - 5V, -5V - +5V):**

In case of positive numbers (MSB = 0):

$$\text{Input voltage [V]} = \frac{\text{PortValue}}{1000}$$

In case of negative numbers (MSB = 1):

$$\text{Input voltage [V]} = \frac{\text{PortValue} - 65536}{1000}$$

**Current signal (0-20mA, 4-20mA):**

$$\text{Input current [mA]} = \frac{\text{PortValue}}{1000}$$

**Pt100, Pt1000, Typ J, Typ K:**

In case of positive numbers (MSB = 0):

$$\text{Temperature [}^{\circ}\text{C]} = \frac{\text{PortValue}}{10}$$

In case of negative numbers (MSB = 1):

$$\text{Temperature [}^{\circ}\text{C]} = \frac{\text{PortValue} - 65536}{10}$$

Where:

PortValue is the digitalized value of the input signal.

**Example 1:**

The analog mode is set to 0-10V input.

The digitalized value read over IO-Link is  $15\text{BA}_{\text{hex}} = 5562$ .

In case of voltage input, the dimensioned value has the dimension of mV.

$$\text{Input voltage [V]} = \frac{\text{PortValue}}{1000} = \frac{5562}{1000} = 5.562\text{V}$$

**Example 2:**

The analog mode is set to 0-10V input.

The digitalized value read over IO-Link is  $\text{EC78}_{\text{hex}} = 60536$ .

In case of voltage input, the dimensioned value has the dimension of mV.

$$\text{Input voltage [V]} = \frac{\text{PortValue} - 65536}{1000} = \frac{60536 - 65536}{1000} = -5.000\text{V}$$



### 3 Getting Started

**Example 3:**

The analog mode is set to 4-20 mA input.

The digitalized value read over IO-Link is  $3A9F_{\text{hex}} = 15007$ .

In case of current input, the dimensioned value has the dimension of  $\mu\text{A}$ .

$$\text{Input current [mA]} = \frac{\text{PortValue}}{1000} = \frac{15007}{1000} = 15.007 \text{ mA}$$

**Example 4:**

The analog mode is set to TypJ Thermocouple.

The digitalized value read over IO-Link is  $06F1_{\text{hex}} = 1777$

In case of Thermocouple input, the dimensioned value has the dimension of  $0.1 \text{ }^\circ\text{C}$

$$\text{Temperature [}^\circ\text{C]} = \frac{\text{PortValue}}{10} = \frac{1777}{10} = 177.7 \text{ }^\circ\text{C}$$

4.1. IO-Link Data

<b>BNI IOL-717-002-E023</b>		
Data transmission rate	COM2 (38,4 kBaud)	
Minimal cycle time	10 ms	
Process data length	3 Byte input	
<b>IO-Link Revision</b>	<b>1.1</b>	<b>1.0</b>
Frame typ	2.V	1
Process data cycle time*	10 ms	40 ms

<b>BNI IOL-725-002-E023</b>		
Data transmission rate	COM2 (38,4 kBaud)	
Minimal cycle time	10 ms	
Process data length	2 Byte output	
<b>IO-Link Revision</b>	<b>1.1</b>	<b>1.0</b>
Frame typ	2.V	1
Process data cycle time*	10 ms	20 ms

<b>BNI IOL-730-002-E023</b>		
Data transmission rate	COM2 (38,4 kBaud)	
Minimal cycle time	10 ms	
Process data length	3 Byte input, 2 Byte output	
<b>IO-Link Revision</b>	<b>1.1</b>	<b>1.0</b>
Frame typ	2.V	1
Process data cycle time*	10 ms	60 ms

<b>BNI IOL-740-002-E023</b>		
Data transmission rate	COM2 (38,4 kBaud)	
Minimal cycle time	10 ms	
Process data length	3 Byte input	
<b>IO-Link Revision</b>	<b>1.1</b>	<b>1.0</b>
Frame typ	2.V	1
Process data cycle time*	10 ms	40 ms

\* by min. cycle time

4 IO-Link Interface

4.2. Prozess data / Input data BNI IOL-717-002-E023 / BNI IOL-730-002-E023 / BNI IOL-740-002-E023

Byte	0								1							
Bit	7	6	5	4	3	2	1	0	7	6	5	4	3	2	1	0
Description	Analog input value															

Byte	2							
Bit	7	6	5	4	3	2	1	0
Description	.	.	Switch point 2**	Switch point 1**	.	Wire break*	Underflow	Overflow

Overflow: This bit indicates when the measured signal is higher than the selected range  
 Underflow: This bit indicates when the measured signal is lower than the selected range  
 Wire break: This bit indicates wirebreak condition of the analog port in case of thermocouple input.  
 Switch point: The switch point bits show a switch point overrun. The switch point can be configured by parameter. (see "Switch point Enable", "Switch point 1" and "Switch point 2")

\*Only in case of BNI IOL-730-002-E023 and BNI IOL-740-002-E023

\*\*Only in case of BNI IOL-717-002-E023, BNI IOL-730-002-E023 and BNI IOL-740-002-E023

4.3. Prozess data / Output data BNI IOL-725-002-E023 / BNI IOL-730-002-E023

Byte	0								1							
Bit	7	6	5	4	3	2	1	0	7	6	5	4	3	2	1	0
Description	Analog output value															

4.4. Parameter data / Request data

	DPP	ISDU		Object name	Length	Range	Default value
	Index	Index	Sub-Index				
Identification data	07 <sub>hex</sub>			Vendor ID	2 Byte	read only	0378 <sub>hex</sub>
	08 <sub>hex</sub>						Device ID
	09 <sub>hex</sub>			BALLUFF			
	0A <sub>hex</sub>			www.balluff.com			
	0B <sub>hex</sub>			10 <sub>hex</sub>	0		Vendor name
		11 <sub>hex</sub>	0	Vendor text	15 Byte		BNI00C9 BNI00C8 BNI00C6 BNI00C7
		12 <sub>hex</sub>	0	Product name	20 Byte		Converter Analog Input Converter Analog Output Univers. Analog converter Converter Temperature
		13 <sub>hex</sub>	0	Product ID	7 Byte		
		14 <sub>hex</sub>	0	Product text			
		15 <sub>hex</sub>	0	Serial Nr	16 Byte		
		16 <sub>hex</sub>	0	Hardware Revision	1 Byte		
		17 <sub>hex</sub>	0	Firmware Revision			
	18 <sub>hex</sub>	0	Application Specific Tag	32 bytes	read / write	0 <sub>hex</sub>	

4 IO-Link Interface

	DPP	ISDU		Object name	Length	Range	Default value
	Index	Index	Sub-Index				
Parameter data		52 <sub>hex</sub>	0 1-5	Device Temperature	5 Byte	read only	
		54 <sub>hex</sub>	0	Serial number	16 Byte		16x 30 <sub>hex</sub>
		57 <sub>hex</sub>	0	Operating hours	4 Byte	read only	
		58 <sub>hex</sub>	0	Boot counter	4 Byte	read only	
		59 <sub>hex</sub>	0	Process data alignment	1 Byte	0..1	0
		F0 <sub>hex</sub>	0	Analog mode	1 Byte	0 <sub>hex</sub> -A <sub>hex</sub>	FF <sub>hex</sub>
		F1 <sub>hex</sub>	0	Resolution	1 Byte	0..3	0
		F2 <sub>hex</sub>	0	Pin assignment*	1 Byte	0..3	0
		F3 <sub>hex</sub>	0	Pt100/ Pt1000 mode**	1 Byte	0..3	2
		F5 <sub>hex</sub>	0	Process data format	1 Byte	0..2	0
		F6 <sub>hex</sub>	0	Switch Point 1****	2 bytes	0 <sub>hex</sub> -FFFF <sub>hex</sub>	0
		F7 <sub>hex</sub>	0	Switch Point 2****	2 bytes	0 <sub>hex</sub> -FFFF <sub>hex</sub>	0
		F8 <sub>hex</sub>	0 1-2	Switch Point Enable****	1 Byte	0..2	0
		F9	0	Thermocouple grounding**	1 Byte	0..1	
		FA <sub>hex</sub>	0	Fault state outputs***	1 Byte	0..3	0

\*Not implemented in case of BNI IOL-740-002-E023

\*\* Only in case of modules with Pt100/Pt1000 function

\*\*\* Only in case of modules with output

\*\*\*\* Only in case of modules with input

**Device  
Temperature  
52<sub>hex</sub>**

The device measures its temperature during it is powered. The device stores the minimum and maximum temperature values measured during life-time and since last start-up.

The temperature value is stored as a signed 8 bit integer, with 1 °C resolution.

For example:

1E<sub>hex</sub> = 30<sub>dec</sub> = 30 °C

FD<sub>hex</sub> = -3<sub>dec</sub> = -3 °C

Subindex	Data
0	All values
1	Actual device temperature
2	Maximum device temperature since last power-on
3	Minimum device temperature since last power-on
4	Maximum temperature lifetime
5	Minimum temperature lifetime

**Setting the  
serial number  
54<sub>hex</sub>**

The serial number has a default value of 16x 00<sub>hex</sub>.

In order to use the "Identity" master validation mode, a serial number can be set using this parameter.

This prevents a device from connecting to the wrong master port

**Note**

It is recommended to set a unique serial number for each device, and use the "Identity" master validation mode.

---

**Operating  
hours  
57<sub>hex</sub>**

The operating hours counter counts the number of usage hours during the lifetime of the device.

**Boot counter  
58<sub>hex</sub>**

The boot counter counts the number of start-up.

4 IO-Link Interface

**Process data alignment**  
59<sub>hex</sub>

The analog values are sent as a 16 bit values over the IO-Link in process data. In case of 10, 12 or 14 bit resolution the analog value is padded with zeros in order to fill the 16 bit in the process data. The justification of the 10, 12 or 14 bit value can be set in Process data alignment ISDU register.

0 = Left justified  
1 = Right justified

Analog values in process data in case of left justification for different resolutions.

Byte	0								1							
Bit	7	6	5	4	3	2	1	0	7	6	5	4	3	2	1	0
MSB	10 bit analog value								LSB							
	12 bit analog value												LSB			
	14 bit analog value														LSB	
	16 bit analog value															

Analog values in process data in case of right justification for different resolutions.

Byte	0								1								
Bit	7	6	5	4	3	2	1	0	7	6	5	4	3	2	1	0	
MSB								10 bit analog value								LSB	
						MSB	12 bit analog value										LSB
				MSB		14 bit analog value										LSB	
	16 bit analog value																LSB



**Note**

The process data alignment does not have effect in case of dimensioned data format

**Analog mode**  
F0<sub>hex</sub>

The mode of the analog ports can be set with this ISDU register. This ISDU can be written with different values depending on the Analog Converter Variant.

**BNI IOL-717-002-E023:**

- 00<sub>hex</sub> = Voltage input, 0V - 10V
- 01<sub>hex</sub> = Current input, 4mA – 20 mA
- 02<sub>hex</sub> = Voltage input, 5V – 10V
- 03<sub>hex</sub> = Voltage input, -10V – 10V
- 04<sub>hex</sub> = Voltage input, 0V – 5V
- 05<sub>hex</sub> = Current input, 0mA – 20 mA
- 06<sub>hex</sub> = Voltage input, -5V - +5V
- 07<sub>hex</sub> = Pt100
- 08<sub>hex</sub> = Pt1000
- FF<sub>hex</sub> = Port is switched off

**BNI IOL-725-002-E023:**

00<sub>hex</sub> = Voltage output, 0V - 10V  
01<sub>hex</sub> = Current output, 4mA – 20 mA  
02<sub>hex</sub> = Voltage output, 5V – 10V  
03<sub>hex</sub> = Voltage output, -10V – 10V  
04<sub>hex</sub> = Voltage output, 0V – 5V  
05<sub>hex</sub> = Current output, 0mA – 20 mA  
06<sub>hex</sub> = Voltage output, -5V - +5V  
FF<sub>hex</sub> = Port is switched off

**BNI IOL-730-002-E023:**

00<sub>hex</sub> = Voltage input/output, 0V - 10V  
01<sub>hex</sub> = Current input/output, 4mA – 20 mA  
02<sub>hex</sub> = Voltage input/output, 5V – 10V  
03<sub>hex</sub> = Voltage input/output, -10V – 10V  
04<sub>hex</sub> = Voltage input/output, 0V – 5V  
05<sub>hex</sub> = Current input/output, 0mA – 20 mA  
06<sub>hex</sub> = Voltage input/output, -5V - +5V  
07<sub>hex</sub> = Pt100  
08<sub>hex</sub> = Pt1000  
09<sub>hex</sub> = Type J thermocouple  
0A<sub>hex</sub> = Type K thermocouple  
FF<sub>hex</sub> = Port is switched off

**BNI IOL-740-002-E023:**

07<sub>hex</sub> = Pt100  
08<sub>hex</sub> = Pt1000  
09<sub>hex</sub> = Type J thermocouple  
0A<sub>hex</sub> = Type K thermocouple  
FF<sub>hex</sub> = Port is switched off

In case of BNI IOL-730-002-E023, when voltage or current type analog mode has been selected, the direction of the signal (input or output) will be determined by the Pin Assignment ISDU (F2<sub>hex</sub>)

**Attention!**

Changing the analog mode of the port to voltage or current input, +24V will be switched between pin1 and pin3, in order to supply the analog sensor. Be sure, that no Pt100 or Pt1000 sensor is connected to the analog port. The +24V supply voltage can damage the RTD sensor.

---



4 IO-Link Interface

**Resolution**  
F1<sub>hex</sub>

The resolution of the analog value can be set with this ISDU register.

- 0 = 16 bit resolution
- 1 = 14 bit resolution
- 2 = 12 bit resolution
- 3 = 10 bit resolution



**Note**

The resolution does not have effect in case of dimensioned data format.

**Pin assignment**  
F2<sub>hex</sub>

In case of voltage or current signal the source pin (pin 2 or pin 4) can be selected with an ISDU.

**BNI IOL-717-002-E023:**

Value	Function	Input signal+	Input signal-
0	Pin4 input	Pin4	Pin3
2	Pin2 input	Pin2	Pin3

**BNI IOL-725-002-E023:**

Value	Function	Output signal+	Output signal-
1	Pin4 output	Pin4	Pin2
3	Pin2 output	Pin2	Pin4

**BNI IOL-730-002-E023:**

Value	Function	Input/output signal+	Input/output signal-
0	Pin4 input	Pin4	Pin3
1	Pin4 output	Pin4	Pin2
2	Pin2 input	Pin2	Pin3
3	Pin2 output	Pin2	Pin4

**BNI IOL-740-002-E023:**

This ISDU is not implemented, because in case of Pt100, Pt1000 and thermocouple the pin-out of the analog port is fixed.

**Pt100/Pt1000 mode F3<sub>hex</sub>** The measurement method for the Pt sensor can be set with this ISDU register. This ISDU is not implemented in case of BNI IOL-725-002-E023.

- 0 = 2 wire measurement
- 1 = 3 wire measurement
- 2 = 4 wire measurement

**Process data format F5<sub>hex</sub>** The analog value can be represented in different formats in the process data.

- 0 = Signed
- 1 = Unsigned
- 2 = Dimensioned (mV,  $\mu$ A,  $\times 0.1$  °C)

**Switch point 1, F6<sub>hex</sub>**  
**Switch point 2, F7<sub>hex</sub>** Two switch points can be set. When the analog value is greater than the value of the switch point, the corresponding bit in the process data will be set. Each switch point ISDU register is 2 byte long.

**Subindex 0:**

Byte	0	1
	Switch Point X	

In order to avoid flickering of the switch point bit in process data, the switch point is evaluated with hysteresis. The hysteresis for different input types are listed in the table above.

Input type	Hysteresis
Voltage	5 mV
Current	10 $\mu$ A
Temperature	1 °C

---

**Note**  
 The switch point value must be set according to the resolution and process data format. The switch point value is always right justified.

---

**Switch point enable F8<sub>hex</sub>** Each switching point can be enabled or disabled. When a switch point is disabled, the corresponding bit in the process data will be set to 0. When switch point is enabled, the analog value will be compared to the switch point value, and the corresponding bit will be set in the process data according to the result of the comparison.

4 IO-Link Interface

**Thermocouple grounding**  
F9<sub>hex</sub>

There are three types of thermocouples: ungrounded, grounded and exposed. The BNI IOL-7XX-002-E023 is able to measure all of them, but in case of grounded thermocouple the measurement range is reduced. The thermocouple type must be set in the ISDU in order to measure the thermocouple correct.

- 0 = Ungrounded thermocouple
- 1 = Grounded thermocouple

The ungrounded measurement mode should be selected in case of ungrounded and in case of exposed thermocouple. In case of exposed thermocouple the hot junction must not have galvanic connection to conductive surfaces. In case of grounded thermocouple the sheath of the thermocouple must be connected to the ground.

**Fault state outputs**  
FA<sub>hex</sub>

In case of analog outputs (BNI IOL-725-002-E023 or BNI IOL-730-002-E023 configured as output) a fault state value can be set with this ISDU. When the IO-Link communication is lost, or the Master sets the PDO Valid (process data output valid) flag to inactive, the Analog Converter will drive its outputs according to the fault state settings.

Value	Output state in case of fault state
0	Output will be set to minimal value according to the selected output signal range
1	Output will be set to the middle value according to the selected output signal range
2	Output will be set to maximal value according to the selected output signal range
3	The last valid output value will be kept.

## 4.5. Error

Error Code	Description
0x8011	Index not available
0x8012	Subindex not available
0x8023	Access Denied
0x8030	Parameter Value out of Range
0x8033	Parameter length overrun
0x8034	Parameter length underrun

## 4.6. Events

IO-Link Revision 1.0	
Event Code	Description
0x4210	Device temperature over-run
0x4220	Device temperature under-run
0x5112	Low sensor voltage (US)
0x5114	Low actuator voltage (UA)
0x5410	Short circuit on pin1
0x8C00	Internal error
0x8C20	Measurement value is out of range
0x8DF3	Thermocouple wire break detected
IO-Link Revision 1.1	
Event Code	Description
0x4210	Device temperature over-run
0x4220	Device temperature under-run
0x5111	Low sensor voltage (US)
0x5112	Low actuator voltage (UA)
0x7700	Thermocouple wire break detected
0x7710	Short circuit on pin1
0x8C00	Internal error
0x8C20	Measurement value is out of range

---

**Note**  
 The events listed above are available in the BNI IOL-730-002-E023. This variant implements all analog functionality. The versions, which do not support all functionality, implement only the subset of the events.

---

**Note**  
 The Low actuator voltage event will be sent in case of BNI IOL-730-002-E023 only, when the analog port is configured as an output.

---

5 Technical Data

5.1. Dimensions

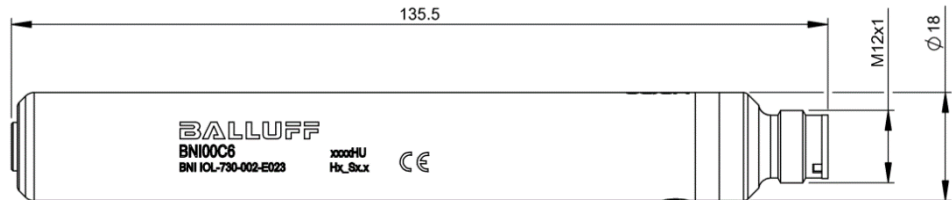

5.2. Mechanical Data

Housing material	Stainless steel housing
IO-Link-Port	M12, A-coded, male,
Analog Ports	M12, female, 5-poles
Enclosure rating per IEC 60529	IP67 (only when plugged in and threaded in)
Weight	ca. 105 g
Dimensions (L x D in mm)	135.5 x 18

5.3. Electrical Data

Operating conditions	18 ... 30,2 V DC, per EN 61131-2
Ripple	< 1 %
Current draw without load	≤ 60 mA
Load current (Analog port Pin1) BNI IOL-717-002-E023 BNI IOL-740-002-E023 BNI IOL-730-002-E023 configured as analog input	≤ 200 mA
Load current (Analog port Pin1) BNI IOL-725-002-E023 BNI IOL-730-002-E023 configured as analog output	≤ 1.4 A
Voltage input measuring error	<±0.1% full-scale, <2 mV, which is greater
Current input measuring error	<±0.1% full-scale, <4 uA, which is greater
Pt100, Pt1000 input measuring error	<±0.2% full-scale, <0.2 °C, which is greater
TypJ thermocouple measuring error	<0.5 °C
TypK thermocouple measuring error	-180 °C - -100 °C: <1 °C -100 °C - +1370 °C: <0.5 °C
Voltage output accuracy	no output load: <±0.1% full-scale, <5 mV, which is greater
Current output accuracy	<±0.2% full-scale, <10 uA, which is greater
Voltage output load	>10 kOhm
Current output load	<500 Ohm
Temperature coefficient	<±0.01% / °C

5.4. Operating conditions

Operating temperature	-5 °C ... +70 °C
Storage temperature	-25 °C ... +70 °C

## 5.5. LED indicators

## Status LEDs

	Indicator	Function
<b>IO-Link communication</b>	Green	No communication
	Green, negative pulsed	Communication OK
<b>Power supply LED</b>	Green	US and UA power supply are OK
	Green, slow flashing (2 Hz)	Power supply UA is not OK
	Green, fast flashing (4 Hz)	Power supply US is not OK
	Red, fast flashing (4 Hz)	Short circuit on Pin1 of analog connector
	Red	Internal error
	Off	Power supply US is <15V

**Note**

The power supply LED shows the state of the UA power supply only in case of BNI IOL-725-002-E023 and BNI IOL-730-002-E023. In case of BNI IOL-730-002-E023 the LED indicates the state of UA power supply only, when the analog port is configured as an output.

6 Appendix

6.1. Type designation code

BNI IOL-7xx-002-E023

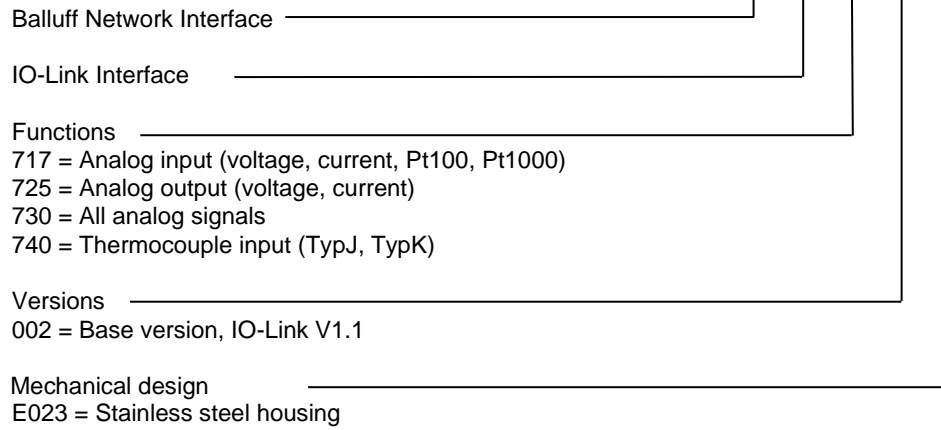

6.2. Order information

Product ordering code	Order code
BNI IOL-717-002-E023	BNI00C9
BNI IOL-725-002-E023	BNI00C8
BNI IOL-730-002-E023	BNI00C6
BNI IOL-740-002-E023	BNI00C7

**[www.balluff.com](http://www.balluff.com)**

Balluff GmbH  
Schurwaldstrasse 9  
73765 Neuhausen a.d.F.  
Germany  
Tel. +49 7158 173-0  
Fax +49 7158 5010  
[balluff@balluff.de](mailto:balluff@balluff.de)